

# Naomi

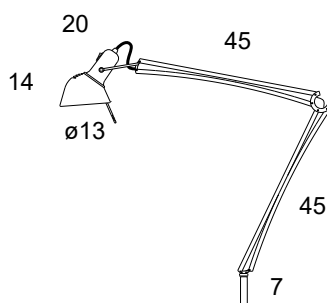

Yaacov Kaufman, 1998

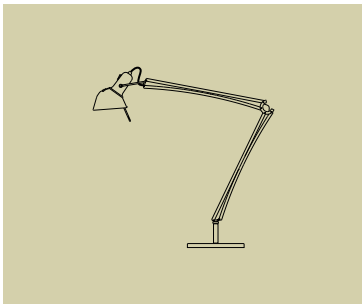

Table lamp in aluminium alloy with a base in steel and aluminium. Extensible and totally pivoting arm; diffuser head can rotate by 360°.



Base not included

|                        |                     |   |
|------------------------|---------------------|---|
| <b>TECHNICAL DATAS</b> | Product Name (code) | <b>Naomi 2 (300)</b>  |
|                        | Certificates        | <b>CE</b>   |
|                        | Norms               | <b>EN 60-598-1 (CEI 34-21)</b>  |
|                        | Light sources       | <b>MAX 60W I - 75W HAL - E27/E26 (not included)</b>   |
|                        | Available           | <b>230V (Europe) - 120V (USA - Japan) - 240V (UK)</b><br><i>(fittings come with appropriate plug)</i> |
|                        | Insulation Class    | <b>II</b>   |
|                        | Protection Class    | <b>IP20</b>   |
|                        | Packaging           | <b>0,055m<sup>3</sup> - 2,25Kg</b>  |

|                |   |   |   |
|----------------|---|---|---|
| <b>COLOURS</b> |  |  |  |
|                | Black   | Anodised  | Polished  |
|                | Soft-touch  | Aluminium   | Aluminium   |
|                |   |   |   |

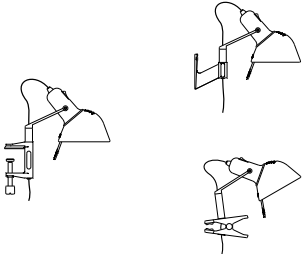
|               |   |   |   |
|---------------|---|---|---|
| <b>FAMILY</b> |  |  |  |
|               | Naomi   | Naomi Terra   | Naomi Head  |
|               |   |   |   |
|               |   |   |   |

# Naomi Terra

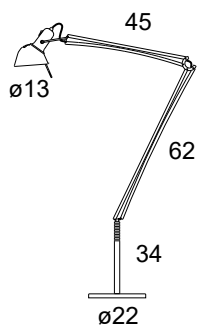

Yaacov Kaufman, 1998

Floor lamp in aluminium alloy with a base in steel and aluminium. Extensible and totally pivoting arm; diffuser head can rotate by 360°.



Base not included

|                        |                                   |   |
|------------------------|-----------------------------------|---|
| <b>TECHNICAL DATAS</b> | Product Name (code)               | <b>Naomi Terra (305)</b>  |
|                        | Certificates                      | <b>CE</b>   |
|                        | Norms                             | <b>EN 60-598-1 (CEI 34-21)</b>  |
|                        | Light sources                     | <b>MAX 60W I - 75W HAL - E27/E26 (not included)</b>   |
|                        | Available                         | <b>230V (Europe) - 120V (USA - Japan) - 240V (UK)</b><br><i>(fittings come with appropriate plug)</i> |
|                        | Insulation Class                  | <b>II</b>   |
|                        | Protection Class                  | <b>IP20</b>   |
| Packaging              | <b>0,062m<sup>3</sup> - 2,9Kg</b> |   |

|                |   |   |   |
|----------------|---|---|---|
| <b>COLOURS</b> |  |  |  |
|                | Black<br>Soft-touch   | Anodised<br>Aluminium   | Polished<br>Aluminium   |

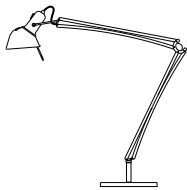
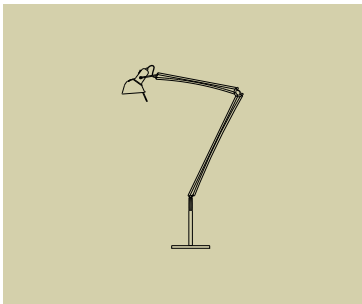
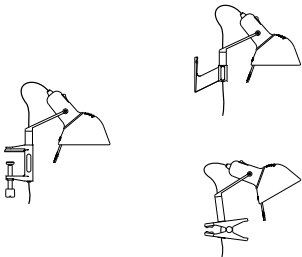
|               |   |  |   |
|---------------|---|--|---|
| <b>FAMILY</b> |  |  |  |
|               | Naomi   | Naomi Terra  | Naomi Head  |

# Naomi base

Yaacov Kaufman, 1998



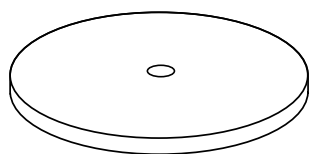



Base, dedicated to Naomi and Naomi Terra, made of steel.



∅22



|                        |                     |                                   |
|------------------------|---------------------|-----------------------------------|
| <b>TECHNICAL DATAS</b> | Product Name (code) | <b>Naomi base (310)</b>           |
|                        | Certificates        | <b>CE</b>                         |
|                        | Norms               |                                   |
|                        | Light sources       |                                   |
|                        | Available           |                                   |
|                        | Insulation Class    |                                   |
|                        | Protection Class    |                                   |
|                        | Packaging           | <b>0,003m<sup>3</sup> - 4,5Kg</b> |

|                |   |   |   |
|----------------|---|---|---|
| <b>COLOURS</b> |  |  |  |
|                | Black<br>Soft-touch   | Chrome  | Brushed   |
|                | <b>For body finish:</b>   |   |   |
|                |  |  |  |
|                | Black<br>Soft-touch   | Polished<br>Aluminium   | Anodised<br>Aluminium   |

## Clamp-on

### Tangram/Naomi

Clamp on, dedicated to Tangram and Naomi, made out of die-cast aluminium and steel.

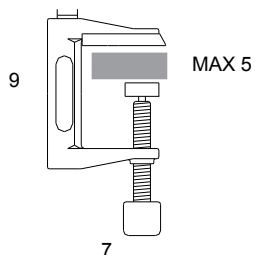

Product Name (code) **Clamp-on (112)**  
Packaging **0,005m<sup>3</sup> - 0,28Kg**

Polished Aluminium

## Wall Attachment

### Tangram/Naomi

Wall attachment, dedicated to Tangram and Naomi, made out of die-cast aluminium.

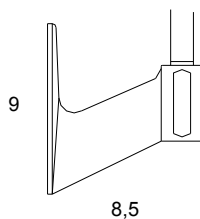

Product Name (code) **Wall Attachment (113)**  
Packaging **0,005m<sup>3</sup> - 0,22Kg**

Polished Aluminium

## Table Mount

### Tangram/Naomi

Table mount, dedicated to Tangram and Naomi, made out of aluminium.

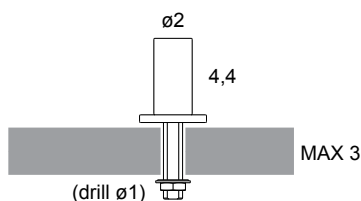

Product Name (code) **Table Mount (332)**  
Packaging **0,002m<sup>3</sup> - 0,16Kg**

Polished Aluminium