

Designed by Louis Weisdorf

PRODUCT



COLORS



// All brass

//White / Brass

// Black/Brass

// All chrome

// Chrome/Black

DESCRIPTION

The Multi-Lite was first drawn in 1972 when Louis Weisdorf did an exception to his own design custom of using multiple repeating elements. Instead it reflects his passion for diversity. The Multi-Lite pendant has two individual rotating shades and can be transformed into multiple combinations where the light can be directed upwards, downwards or exude an asymmetrical art light. The lamp is available in different colors and all the shades are white lacquered inside.

VERSION - MULTI-LITE S PENDANT

Colour codes are indicative:

All Brass - brass colored cable
 Brass/Charcoal Black - RAL 9011 - Gloss level 5 - black cable
 Brass/White - RAL 9003 - Gloss level 15 - white cable
 All Chrome - black cable
 Chrome/Black - RAL 9005 - Gloss level 15 - black cable

Canopy:

- Brass on brass versions
- Chrome on chrome versions

MEASUREMENTS

Order item - look for part number in the pricelist.

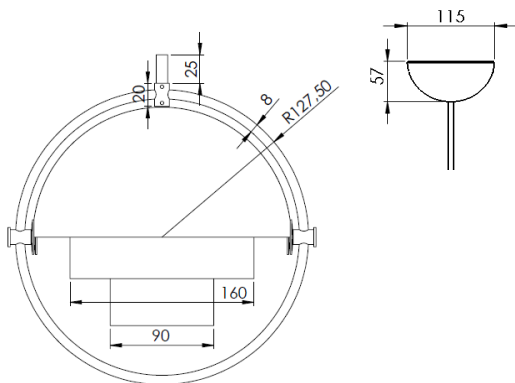

FACTS

MEASUREMENT - L x W x H mm

Lamp height: 255 mm
 Lamp diameter: Ø255 mm
 Canopy size: Ø115 x 57 mm
 Wire length, exposed: Approx.. 4000 mm

WEIGHT ITEM - LAMP INCL. WIRE

1500 G

PACKAGING TYPE

Cardboard box

PACKAGING MEASUREMENT - L x W x H cm

L: 37 x W: 27 x H: 31 cm

WEIGHT PACKAGING - MATERIAL TYPE (recyclable)

- Polystyrene: 270 g
- PE polybag: 30 g
- Cardboard: 570 g

WEIGHT PACKAGING - TOTAL

870 G

NUMBER OF PARCELS

1 pcs.

Designed by Louis Weisdorf

ACCESSORIES

-

ENVIRONMENT

-

TESTS

-

CERTIFICATION AND LABELS

CE-certified

SAFETY INSTRUCTIONS

If the cord or other electrical part is damaged, switch of the lamp and do not use it until it is repaired by a qualified electrician.

INSTALLATION INSTRUCTIONS

Instructions document no. 58-20-009-02

GUBI

CARE INSTRUCTIONS

Wipe the parts with a damp cloth soaked in warm water and a bit of mild detergent. Use only mild cloths for wiping and cleaning. Never scour or abrade metal. Do not use abrasive household cleaners! Do not use acids or alkaline cleaning materials, glass cleaner or household solvents.

TROUBLESHOOTING

If lamp does not light, turn off the power. Check the bulb for a broken filament. Replace bulb if necessary. When turn it on, if the lamp still does not light, please contact customer service at the local dealer. If the external flexible cable or part of this lamp is damaged, it must be repaired by a qualified electrician in order to avoid a hazard.

TECHNICAL INFORMATION

Light sources: T4, 475 Lumens by 42W incandescent, 30W halogen, 4.6W LED (Dimmable). Turn power off when changing light bulb. Installation class: II. This lamp is not approved for outdoor use or use in damp/wet rooms (DZ).

For enquiries contact GUBI AS - CVR: 17948884
Kløvbovej 7-9, 2150 Nordhavn, Copenhagen, Denmark
T +45 49 15 40 40 - info@gubi.dk
GUBI.CO.UK

58 20 009 02 Assembly Instructions Multi-Lite Pendant S EU

ASSEMBLY INSTRUCTIONS
for
Multi-Lite Pendant S



LIGHT SOURCE:

- Socket: E14 base
- Bulb types recommended:



- Recommended light sources:

470 Lumen (≤ 30W halogen, ~ 4-6W LED Dimmable)

- Max. light out put for above lamps:

(≤ 40W incandescent ≤ 30W halogen, ~ 5-6W LED Dimmable)

- Best result is achieved with frosted light bulbs

with a CRI (Colour Rendering Index) larger than 90.

- Lightbulb not included.

- All lamps can be fitted with a dimmer.

- Please contact your local electrician.

*Euro voltage: 230 V

*Frequency: 50 Hz

*Supply voltage: AC power -

*Normally Closed: IP20



Class II / Double insulated







CE-Mark



Luminaires accepted for mounting on a flammable base

GUBI **ASSEMBLY INSTRUCTIONS**
MULTI-LITE PENDANT S

CONTENTS:

The half shades can be moved, and lightened by turning the fixing screws.

1. Assembly

Attach the ceiling bracket to the ceiling where the main voltage falls.



2.

2.1 Find the desired length of cable and cut off the outer isolation.
2.2 Mount the cable in the cable clamp.



3.

Connect lamp cable to the supply wires.



4.

4.1 Place canopy on ceiling bracket and twist approx. 90-120 degrees.
4.2 Place light bulb in lamp and turn the power on.

