

Sestessina led cob



9 cm
3 1/2"

24cm
9 1/2"

17,5 cm
6 3/4"



luminaire	
code CRI ≥ 80	219
code CRI = 95	219H
materials	aluminium
environment	interiors
mounting location	wall
emission	indirect light
weight	1,0 Kg
voltage	230V
ballast	integrated electronic dimmable
dimming	phase-cut
insulation class	1
IP classification	IP20
certifications	CE
design	Luta Bettonica, Mario Melocchi, 2009

light source	
sorgente	LED
number of LED	1
power	20W
flux CRI ≥ 80	1.700 lm
flux CRI = 95	1.300 lm
colour temperature	2.800K
	available at 3.000K / 3.500K / 4.000K
	for orders ≥ 5 pieces

energy label

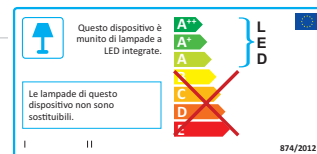

finishes	
	white
	colour on demand monocolour bicolour

versions	
	sestessina alogena white cod 210
	sestessina alogena argento cod 211

Sestessa led cob



33 cm
13"



24 cm
9 1/2"

11 cm
4 1/4"



luminaire	
code CRI ≥ 80	232
code CRI = 95	232H
materials	aluminium
environment	interiors
mounting location	wall
emission	indirect light
weight	1,7 Kg
voltage	230V
ballast	integrated electronic dimmable
dimming	phase-cut
insulation class	1
IP classification	IP20
certifications	CE
design	Luta Bettonica, Mario Melocchi, 2009

light source	
sorgente	LED
number of LED	1
power	20W
flux CRI ≥ 80	2.150 lm
flux CRI = 95	1.550 lm
colour temperature	2.800K
	available at 3.000K / 3.500K / 4.000K
	for orders ≥ 5 pieces

energy label

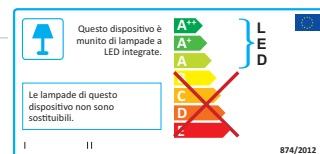

finishes



white



colour on demand
monocolour
bicolour

versions



Sestessa alogena
white
cod 201
cod 205

Sestessa ioduri (HID)
white
cod 203

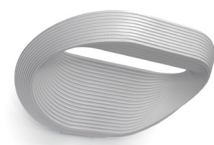

Sestessa alogena
argento
cod 202
cod 206

Sestessa ioduri (HID)
argento
cod 204

Sestessa maxi led cob

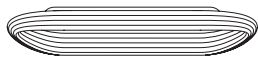

55 cm
21^{5/8}"



24,5 cm
9^{5/8}"

11 cm
4^{1/4}"



luminaire	
code CRI ≥ 80	218
code CRI = 95	218H
materials	aluminium
environment	interiors
mounting location	wall
emission	indirect light
weight	3,6 Kg
voltage	230V
ballast	integrated electronic dimmable
dimming	phase-cut
insulation class	1
IP classification	IP20
certifications	CE
design	Luta Bettonica, Mario Melocchi, 09-13

light source	
sorgente	LED
number of LED	1
power	39W
flux CRI ≥ 80	3.900 lm
flux CRI = 95	2.850 lm
colour temperature	2.800K
	available at 3.000K / 3.500K / 4.000K
	for orders ≥ 5 pieces

energy label

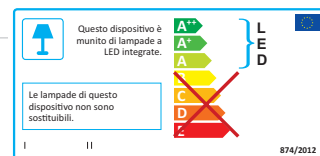

finishes	
white	colour on demand monocolour bicolour

versions	
Sestessa fluo white cod 216	Sestessa fluo argento cod 217

Sestessa terra led cob

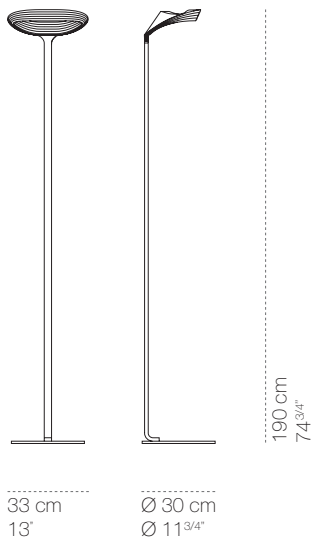

luminaire	
code CRI ≥ 80	221
code CRI = 95	221H
materials	aluminium
environment	interiors
mounting location	floor
emission	diffused and indirect light
weight	9,0 Kg
voltage	230V
ballast	integrated electronic dimmable
dimmer	rompifilo elettronico
insulation class	1
spina	schuko+france 3 poles
IP classification	IP20
certifications	CE pending
design	Luta Bettonica, Mario Melocchi, 2013

light source	
sorgente	LED
number of LED	1
power	39W
flux CRI ≥ 80	3.900 lm
flux CRI = 95	2.850 lm
colour temperature	2.800K
available at 3.000K / 3.500K / 4.000K	
for orders ≥ 5 pieces	

energy label

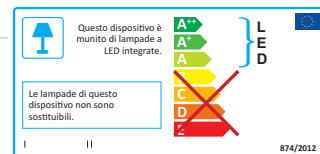

finishes



white
cod 221
cod 221H
cod 222 Swiss plug
cod 222H Swiss plug

colour on demand
monocolour
bicolour

versions



Sestessa terra alogena
white
cod 220
cod 223 Swiss plug

Sestessa terra alogena

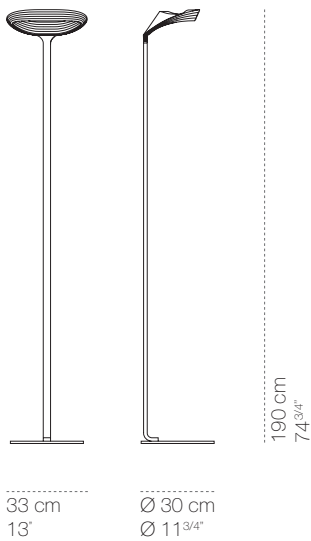

luminaire	
materials	aluminium
environment	interiors
mounting location	floor
emission	diffused and indirect light
weight	9,0 Kg
voltage	230V
dimmer	electronic in-line
insulation class	1
spina	schuko+france 3 poles
IP classification	IP20
certifications	CE pending
design	Luta Bettonica, Mario Melocchi, 2013

light source	
sorgente	halogen R7s
number of bulbs	1
power	230W
flux luminoso	5.060 lm
colour temperature	2.900K

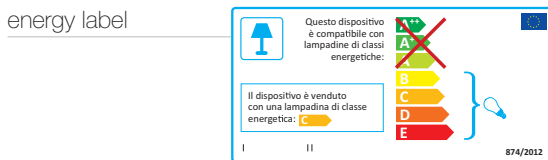

finishes	
	
white cod 230 cod 223 Swiss plug	colour on demand monocolour bicolour

versions

Sestessa terra led cob white cod 221 cod 221H cod 222 Swiss plug cod 222H Swiss plug

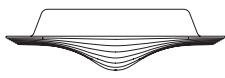
Sestessa plafone led cob

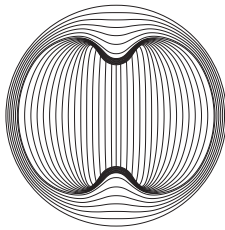

15 cm
5 7/8"



Ø 50 cm
Ø 19 3/4"



luminaire	
code CRI ≥ 80	237
code CRI = 95	237H
materials	aluminium
environment	interiors
mounting location	wall/ceiling
emission	indirect light
weight	6,7 Kg
voltage	230V
ballast	2 x integrated electronic dimmable
dimming	phase-cut
insulation class	1
IP classification	IP20
certifications	CE pending
design	Luta Bettonica, Mario Melocchi, 2013

light source	
sorgente	LED
number of LED	2
power	2 x 26W
flux CRI ≥ 80	2 x 2.400 lm
flux CRI = 95	2 x 2.000 lm
colour temperature	2.800K
	available at 3.000K / 3.500K / 4.000K
	for orders ≥ 5 pieces

energy label

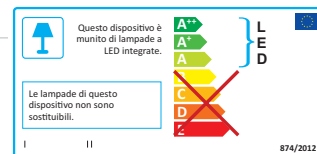

finishes



white
cod 237
cod 237H



colour on demand
monocolour
bicolour

versions



Sestessa
semincasso
led cob
white
cod 236
cod 236H



Sestessa
sospesa
led cob
white
cod 235
cod 235H



Sestessa
cabrio
led cob
white
cod 234
cod 234H

Sestessa semincasso

led cob

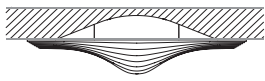

8 cm
3 1/8"

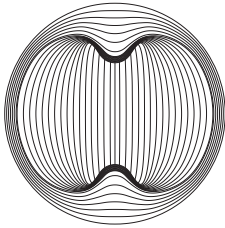

Ø 50 cm
Ø 19 3/4"



luminaire	
code CRI ≥ 80	236
code CRI = 95	236H
materials	aluminium
environment	interiors
mounting location	ceiling/wall
emission	indirect light
weight	4,4 Kg
voltage	230V
ballast	2 x integrated electronic dimmable
dimming	phase-cut
insulation class	1
IP classification	IP20
certifications	CE pending
design	Luta Bettonica, Mario Melocchi, 2013

light source	
sorgente	LED
number of LED	2
power	2 x 26W
flux CRI ≥ 80	2 x 2.400 lm
flux CRI = 95	2 x 2.000 lm
colour temperature	2.800K
	available at 3.000K / 3.500K / 4.000K
	for orders ≥ 5 pieces

energy label

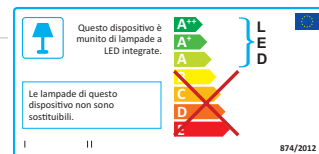

finishes



white
cod 236
cod 236H



colour on demand
monocolour



bicolour

versions



Sestessa
plafone
led cob
white
cod 237
cod 237H



Sestessa
sospesa
led cob
white
cod 235
cod 235H



Sestessa
cabrio
led cob
white
cod 234
cod 234H

Sestessa sospesa led cob

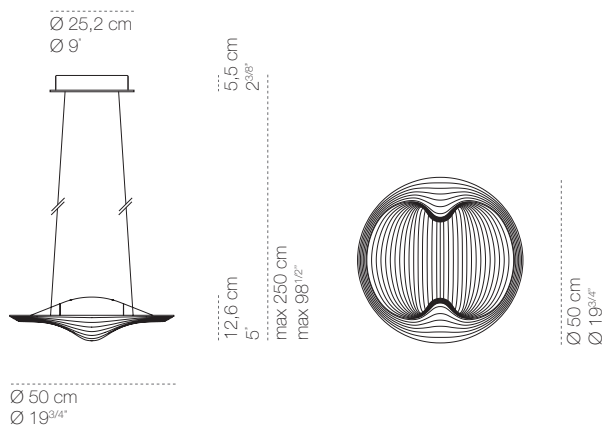



luminaire	
code CRI ≥ 80	235
code CRI = 95	235H
materials	aluminium
environment	interiors
mounting location	ceiling
emission	indirect light
weight	5,9 Kg
voltage	230V
ballast	2 x integrated electronic dimmable
dimming	phase-cut
insulation class	1
IP classification	IP20
certifications	CE pending
design	Luta Bettonica, Mario Melocchi, 2013

light source	
sorgente	LED
number of LED	2
power	2 x 26W
flux CRI ≥ 80	2 x 2.400 lm
flux CRI = 95	2 x 2.000 lm
colour temperature	2.800K
	available at 3.000K / 3.500K / 4.000K
	for orders ≥ 5 pieces

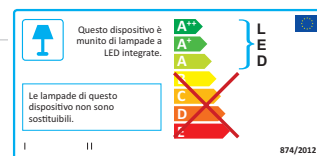
energy label



finishes	
	
white cod 235 cod 235H	colour on demand monocolour bicolour

versions		
		
Sestessa cabrio led cob white cod 234 cod 234H	Sestessa plafone led cob white cod 237 cod 237H	Sestessa semincasso led cob white cod 236 cod 236H

Sestessa cabrio led cob

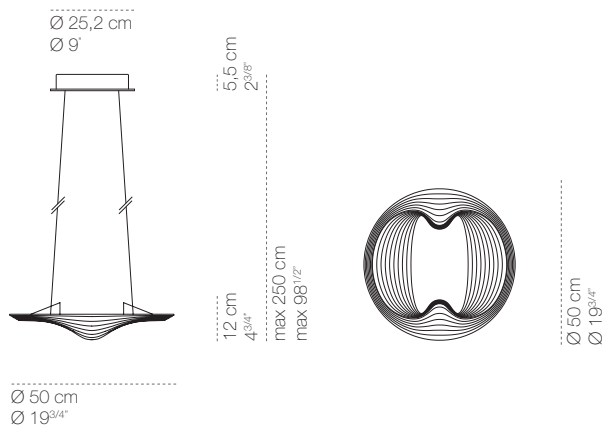

luminaire	
code CRI ≥ 80	234
code CRI = 95	234H
materials	aluminium
environment	interiors
mounting location	ceiling
emission	diffused and indirect light
weight	4,6 Kg
voltage	230V
ballast	2 x integrated electronic dimmable
dimming	phase-cut
insulation class	1
IP classification	IP20
certifications	CE
design	Luta Bettonica, Mario Melocchi, 2013

light source	
sorgente	LED
number of LED	2
power	2 x 26W
flux CRI ≥ 80	2 x 2.400 lm
flux CRI = 95	2 x 2.000 lm
colour temperature	2.800K
	available at 3.000K / 3.500K / 4.000K
	for orders ≥ 5 pieces

energy label

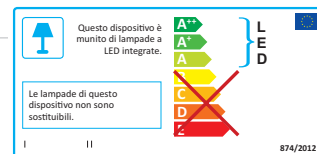

finishes



white
cod 234
cod 234H

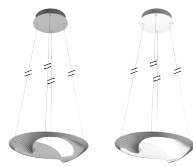

colour on demand
monocolour
bicolour

versions



Sestessa
cabrio
led cob
white
cod 235
cod 235H



Sestessa
plafone
led cob
white
cod 237
cod 237H



Sestessa
semincasso
led cob
white
cod 236
cod 236H